

Technical data sheet for

# INDUCTION COOKTOP 450mm

- ROUND INDUCTION ZONE

IN8100R3-B, IN8100R3-LS, IN8100R3-CB, IN8100R5-B, IN8100R5-LS, IN8100R5-CB,



IN8100R5-LS

- Heavy-duty construction
- One 270mm dia round induction zone
- 3.5kW or 5kW heating
- Automatic pan detection switches induction zone off when pan removed
- 3 models of base unit
- Stainless steel exterior
- Easy clean
- Easy service
- Fully modular
- Low back models (INL) available

## Induction Zone Options

- R3 - 3.5kW round induction
- R5 - 5kW round induction

## Series Options

- IN - Standard splashback models
- INL - Low back models
- INB - Bold vitreous enamel colour front finish on standard splashback models
- INLB - Bold vitreous enamel colour front finish on low back models

## Overall Construction

### COOKTOP

- Welded hob with 2.0mm stainless steel hob top
- Splashback and side panels 1.2mm stainless steel
- Front panels 0.9mm stainless steel
- 6mm thick ceramic glass cooking surface

### BENCH MOUNT (supplied as – B model)

- Four 63mm dia. heavy-duty 1.2mm 304 stainless steel bench legs with adjustable feet
- Adjustable height 80mm – 105mm

### LEG STAND (supplied as – LS model)

- Fully modular for matched suite finish
- Framed top for connection to Cooktop
- 63mm dia. heavy-duty 1.2mm 304 stainless steel legs with four adjustable feet
- Fully modular framed stand shelf with 0.9mm 304 stainless steel finish
- Quick assembly design

### CABINET BASE (supplied as – CB model)

- Fully modular for match suite finish
- Double skin 0.9mm 304 stainless steel interior and exterior
- 63mm dia. heavy-duty 1.2mm 304 stainless steel legs with four adjustable feet

## Controls

- Large easy use control knob
- Infinitely variable power controls for each induction zone
- Heating ON indicator lights (green) including pan detection indication
- Error mode indicator light (green)

## Cleaning and Servicing

- All models with easy clean stainless steel external finish
- Fully sealed cooking surface
- Removable full stainless steel air intake filters (induction cooling)
- Front service access

Technical data sheet for

# INDUCTION COOKTOP 450mm

- ROUND INDUCTION ZONE

IN8100R3-B, IN8100R3-LS, IN8100R3-CB, IN8100R5-B, IN8100R5-LS, IN8100R5-CB,

## Specifications

### COOKTOP

1 x 3.5kW induction zone  
or  
1 x 5.0kW induction zone  
Ø 270mm induction zones

### Electrical requirements

#### IN8100R3

3.5kW, 230-240V, 50/60Hz, 1P+N+E  
15A / phase

#### IN8100R5

5.0kW, 400-415V, 50/60Hz, 3P+E  
7A / phase

### DIMENSIONS

#### Bench model

Width 450mm  
Depth 805mm  
Height 355mm  
Incl. splashback 570mm  
Incl. low back 410mm

#### All models (excluding Bench model)

Width 450mm  
Depth 805mm  
Height 915mm  
Incl. splashback 1130mm  
Incl. low back 970mm

### NETT WEIGHT

88kg

### PACKING DATA

0.54m<sup>3</sup>, 130kg  
Width 495mm  
Depth 865mm  
Height 1255mm

### OPTIONS AT EXTRA COST

Castors  
Plinth mounting

IN8100-B

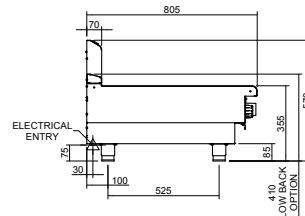
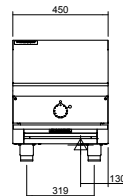

IN8100-LS

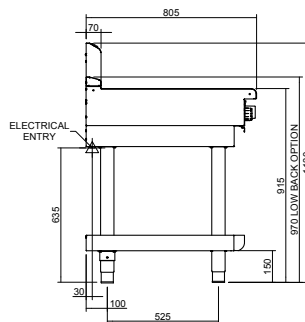
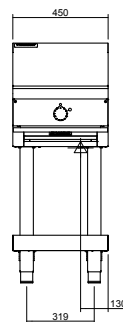

IN8100-CB

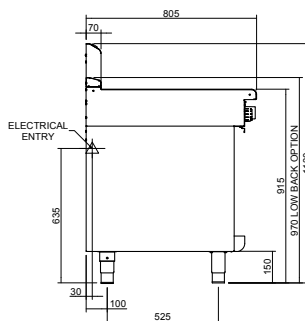
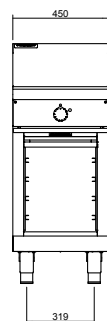

IN8100R3  
IN8100R5

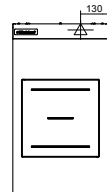

[moffat.com.au](http://moffat.com.au)  
[moffat.co.nz](http://moffat.co.nz)

Australia  
[moffat.com.au](http://moffat.com.au)

#### Moffat Pty Limited

Victoria/Tasmania  
740 Springvale Road  
Mulgrave, Victoria 3170  
Telephone +613-9518 3888  
Facsimile +613-9518 3833  
[vsales@moffat.com.au](mailto:vsales@moffat.com.au)

New South Wales  
Telephone +612-8833 4111  
[nswsales@moffat.com.au](mailto:nswsales@moffat.com.au)

South Australia  
Telephone +613-9518 3888  
[vsales@moffat.com.au](mailto:vsales@moffat.com.au)

Queensland  
Telephone +617-3630 8600  
[qldsales@moffat.com.au](mailto:qldsales@moffat.com.au)

Western Australia  
Telephone +618-9413 2400  
[wasales@moffat.com.au](mailto:wasales@moffat.com.au)

New Zealand  
[moffat.co.nz](http://moffat.co.nz)

#### Moffat Limited

Rolleston  
45 Illinois Drive  
Izone Business Hub  
Rolleston 7675  
Telephone +64 3-983 6600  
Facsimile +64 3-983 6660  
[sales@moffat.co.nz](mailto:sales@moffat.co.nz)

Auckland  
Telephone +64 9-574 3150  
[sales@moffat.co.nz](mailto:sales@moffat.co.nz)



In line with policy to continually develop and improve its products, Moffat Limited reserves the right to change specifications and design without notice.

© Copyright Moffat Ltd  
AN.W8.01/22

an Ali Group Company



The Spirit of Excellence